



HKG - USA Freighter Schedule

Effective: Oct 27, 2019

HKG - CVG / JFK / ORD FLIGHT	AC Type	DAY	HKG	ANC	JFK	ORD	CVG
PO8024 ¹ PO1826 ⁴	777F	D1 D1-4	D 09:05 D 21:45				A 11:15 A 23:55
PO8991 ³ PO948 PO8991 ³ PO948 ⁴ PO243 PO948 PO736 PO1826 ⁴ PO238 PO1826 ⁴ PO948 PO946 ⁴	744F	D1 D1,3 D2-5 D2,4 D3 D5 D5 D6 D6 D7 D7	D 15:10 D 18:00 D 10:30 D 18:00 D 13:40 D 17:55 D 18:20 D 20:45 D 12:15 D 22:25 D 05:30 D 10:30	A 08:10 / D 09:40 A 11:00 / D 12:15 A 03:30 / D 05:00 A 11:00 / D 12:15 A 06:40 / D 08:10 A 10:40 / D 13:15 A 11:20 / D 12:35 A 13:45 / D 15:15 A 05:15 / D 06:45 A 15:25 / D 16:55 A 22:15 -1 / D 23:45 -1 A 03:30 / D 04:45			A 19:55 A 22:30 A 15:15 A 22:30 A 18:25 A 22:30 A 22:50 A 01:30 +1 A 17:00 A 03:10 +1 A 10:00 A 15:00
PO1876 ⁴ PO914 ⁴ PO914 ⁴	777F	D2,4 D3 D5	D 06:00 D 06:05 D 06:00	A 23:00 / D 00:25 A 23:05 / D 00:25 A 23:00 / D 00:25	A 11:25 / D 13:25 +1 A 11:25 / D 13:25 +1 A 11:25 / D 13:25 +1	A 14:55 +1 A 14:55 +1 A 14:55 +1	
PO8995 ³ PO1876 ⁴	744F	D6 D7	D 10:30 D 06:00	A 03:30 / D 12:00 A 23:00 -1 / D 00:25	A 23:00 / D 01:00 +1 A 11:25 / D 13:25	D 03:20 +1 D 15:45	
PO918 ⁴	777F	D7	D 06:50	A 23:50 -1 / D 01:20	A 13:05 / D 16:30	D 19:15	
PO948 / 752	744F / 744F	D3	D 18:00	A 11:00 / D 12:15	A 22:30 / D 12:35 +1	A 15:10 +1	
PO243 / 752	744F / 744F	D3	D 13:40	A 06:40 / D 08:15	A 18:25 / D 12:35 +1	A 15:10 +1	
PO8997 ³	744F	D7	D 10:30	A 03:30 / D 05:00	A 13:50 / D 15:50	D 18:05	
5Y654 ² 5Y654 ²	744F	D4 D7	D 14:50 D 17:40	A 19:10 / D 21:00 A 22:00 / D 00:00 +1	A 11:55 / D 12:55 A 13:55 / D 15:25	A 22:25 A 00:55 +1	
PO238 / 214	747-8F	D1,3	D 15:50	A 20:10 / D 22:25	A 00:15 +1 / D 02:15 +1	A 00:30 +1	
PO238 / 214	747-8F / 747-8F	D2,4	D 16:10	A 20:30 / D 22:25	A 00:15 +1 / D 02:15 +1	A 00:30 +1	

* Indicate Code Share Flight
¹ Marketing Carrier is PO. Operating Carrier is Aerologic (3S)
² Marketing Carrier is PO. Operating Carrier is Atlas Air (5Y)
³ Marketing Carrier is PO. Operating Carrier is Kalitta Air (K4)
⁴ Marketing Carrier is PO. Operating Carrier is Southern Air (9S)

▲ Indicate aircraft change
 All times are local time
 Schedule is subject to change without prior notice

HKG - LAX

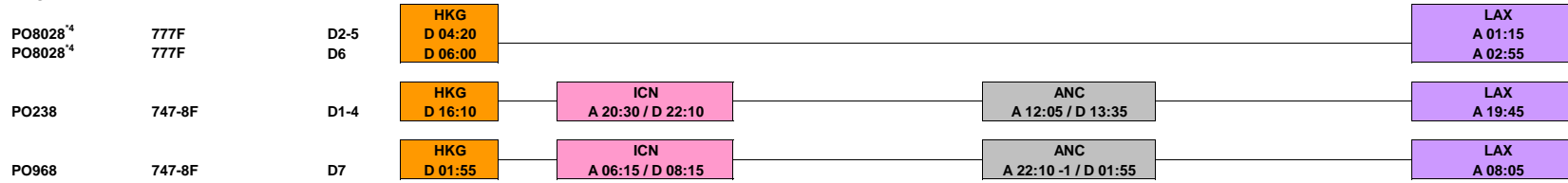

* Indicate Code Share Flight

¹ Marketing Carrier is PO. Operating Carrier is Aerologic (3S)

² Marketing Carrier is PO. Operating Carrier is Atlas Air (5Y)

³ Marketing Carrier is PO. Operating Carrier is Kalitta Air (K4)

⁴ Marketing Carrier is PO. Operating Carrier is Southern Air (9S)

▲ Indicate aircraft change

All times are local time

Schedule is subject to change without prior notice



HKG - USA Freighter Schedule (Additional Flights in peak season)

Effective: Oct 27, 2019

HKG - CVG / LAX
FLIGHT

AC Type

DAY

PO766	744F	D2
PO766	744F	D3,4
PO766	744F	D6

PO243	744F	D6
-------	------	----

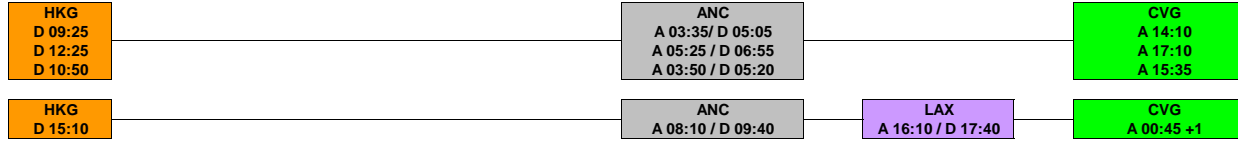

All times are local time
Schedule is subject to change without prior notice



HKG - Europe / India / Middle East Freighter Schedule

Effective: Oct 27, 2019

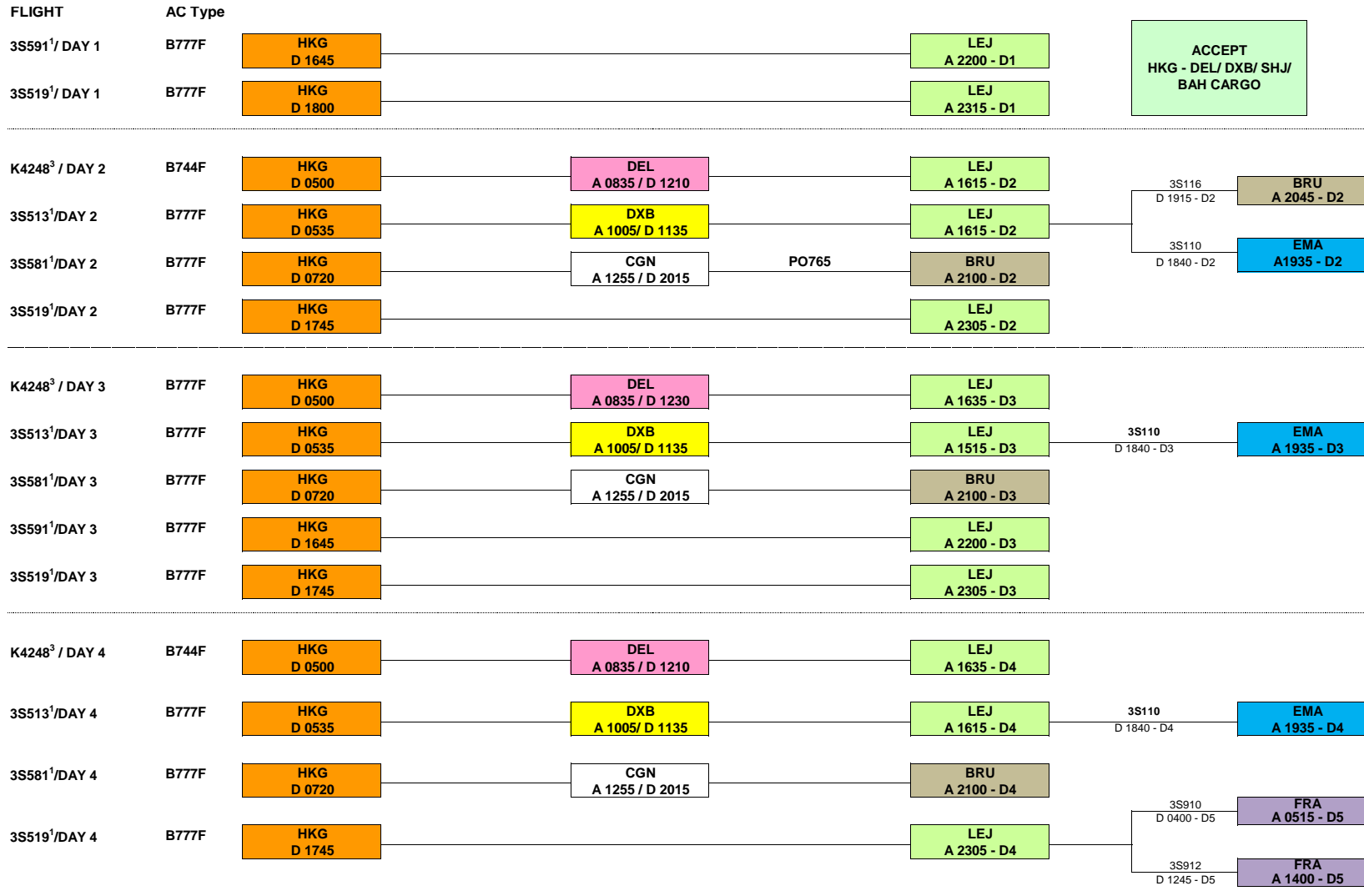



HKG - Europe / India / Middle East Freighter Schedule

Effective: Oct 27, 2019

FLIGHT	AC Type	Origin	Destination	Time
K4248 ³ / DAY 5	B777F	HKG D 0500	DEL	A 0835 / D 1230
			LEJ	A 1635 - D5
3S513 ¹ /DAY 5	B777F	HKG D 0540	DXB	A 1010/ D 1200
			LEJ	A 1535 - D5
3S581 ¹ /DAY 5	B777F	HKG D 0720	CGN	A 1240 / D 1445
			LEJ	A 1600 - D5
3S591 ¹ /DAY 5	B777F	HKG D 1745		
			LEJ	A 2300 - D5
<hr/>				
3S513 ¹ /DAY 6	B777F	HKG D 0535	DXB	A 1005 / D 1200
			FRA	A 1555 - D6
3S583 ¹ /DAY 6	B777F	HKG D 0720		
			LEJ	A 1240 - D6
K4248 ³ / DAY 6	B744F	HKG D 0940	DEL	A 1315 / D 1515
			LEJ	A 1920 - D6
<hr/>				
PO546/DAY 7	B744F	HKG D 0420	BAH	A 0845 / D 1015
			LEJ	A 1425 - D7
9S085 ⁴ /DAY 7	B777F	HKG D 0430	SHJ	A 0920 / D 1115
			LEJ	A 1455 - D7
			Truck service to DXB	
3S599 ¹ /DAY 6	B777F	HKG D 0535	DXB	A 1005/ D 1205
			LEJ	A 1535 - D7
K4247 ³ / DAY 7	B744F	HKG D 0550	BAH	A 1020 / D 1150
			K4244	BRU A 1640 - D7
K4250 ³ / DAY 7	B777F	HKG D 0745	DEL	A 1120 / D 1320
			LEJ	A 1725 - D7
3S521 ¹ /DAY 7	B777F	HKG D 0935		
			LEJ	A 1450 / D1610 - D7
				EMA A 1705- D7

* Indicate Code Share Flight

¹ Marketing Carrier is PO. Operating Carrier is Aerologic (3S)

² Marketing Carrier is PO. Operating Carrier is Atlas Air (5Y)

³ Marketing Carrier is PO. Operating Carrier is Kalitta Air (K4)

⁴ Marketing Carrier is PO. Operating Carrier is Southern Air (9S)

▲ Indicate aircraft change

All times are local

Schedules are subject to change without notice

PO: B747-400F; 3S Aerologic: B777-200F; 9S Southern Air: B777-200F; K4 Kalitta Air: B747-400F



ICN - USA Freighter Schedule

ICN - CVG / ORD
FLIGHT

AC Type

DAY

Effective: Oct 27, 2019

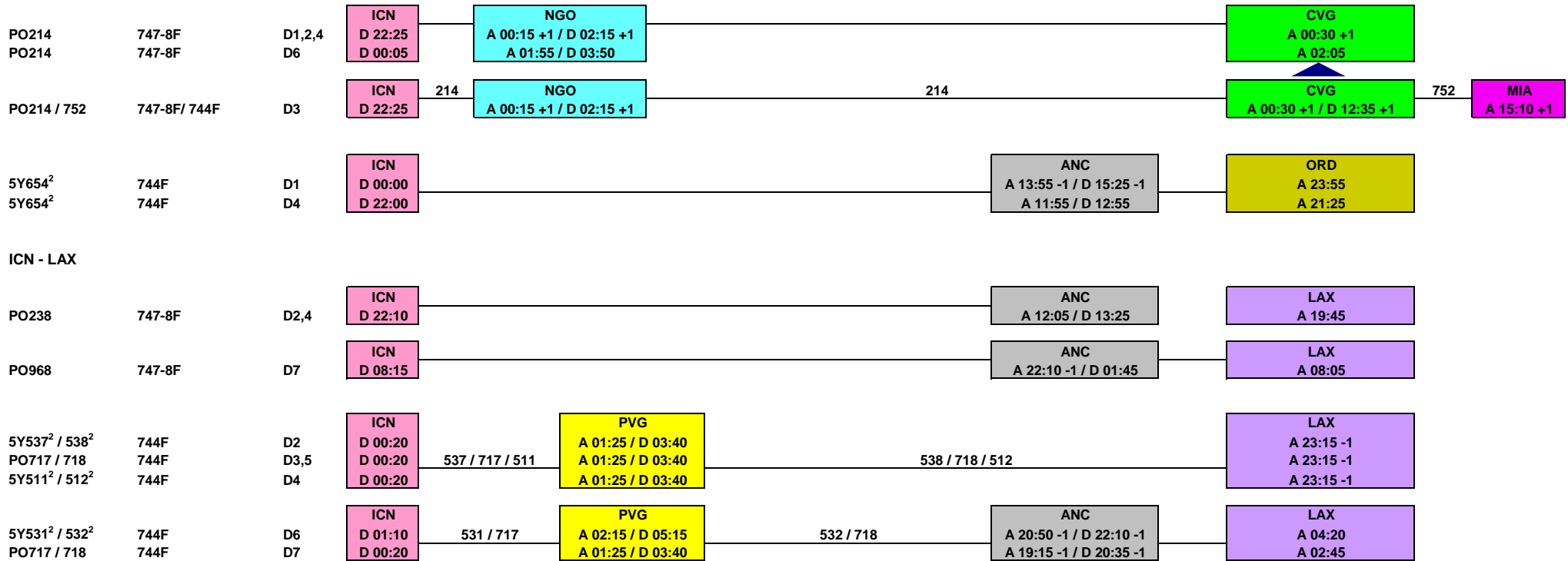

* Indicate Code Share Flight

¹ Marketing Carrier is PO. Operating Carrier is Aerologic (3S)

² Marketing Carrier is PO. Operating Carrier is Atlas Air (5Y)

³ Marketing Carrier is PO. Operating Carrier is Kalitta Air (K4)

⁴ Marketing Carrier is PO. Operating Carrier is Southern Air (9S)

▲ Indicate aircraft change

All times are local time

Schedule is subject to change without prior notice



NRT / NGO - USA Freighter Schedule

Effective: Oct 27, 2019

NGO / NRT - CVG
FLIGHT

AC Type

DAY

FLIGHT	AC Type	DAY	Origin	Destination	Times
PO214	747-8F	D2-5	NGO	CVG	D 02:15 / A 00:30
PO214	747-8F	D6	NGO	CVG	D 03:50 / A 02:05
PO752	744F	D2, 5	NRT	CVG	D 10:10 / A 10:35
				ANC	A 22:50 -1 / D 00:20 +1
PO752	744F	D3	NRT	CVG	D 09:40 / A 10:05
				ANC	A 22:50 -1 / D 23:50 +1
PO752	744F	D4	NRT	CVG	D 10:10 / A 10:35 / D 12:35
				ANC	A 22:50 -1 / D 00:20 +1
PO962	744F	D7	NRT	CVG	D 14:25 / A 14:50
				ANC	A 03:05 / D 04:35
PO211 / 214	744F / 747-8F	D1	NRT	CVG	D 21:45 / A 00:30 +1
PO211 / 214	744F / 747-8F	D2,3,4	NRT	CVG	D 21:40 / A 00:30 +1
PO211 / 214	744F / 744F	D5	NRT	CVG	D 22:05 / A 02:05 +1
			NGO		A 23:00 / D 02:15 +1
			NGO		A 22:55 / D 02:15 +1
			NGO		A 23:20 / D 03:50 +1

NGO / NRT - LAX

FLIGHT	AC Type	DAY	Origin	Destination	Times
5Y511 ² / 5Y512 ²	744F	D3	NRT	LAX	D 08:30 / A 23:15
PO717 / PO718	744F	D4	NRT	LAX	D 08:30 / A 23:15
			ICN		A 11:05 / D 00:20 +1
			ICN		A 11:05 / D 00:20 +1
			PVG		A 01:25 +1 / D 03:40 +1
			PVG		A 01:25 +1 / D 03:40 +1
5Y531 ² / 5Y532 ²	744F	D5	NRT	LAX	D 08:30 / A 04:20 +1
PO717 / PO718	744F	D6	NRT	LAX	D 08:30 / A 02:45 +1
			ICN		A 11:05 / D 01:10 +1
			ICN		A 11:05 / D 00:20 +1
			PVG		A 02:15 +1 / D 05:15 +1
			PVG		A 01:25 +1 / D 03:40 +1
			ANC		A 20:50 / D 22:10
			ANC		A 19:15 / D 20:35

* Indicate Code Share Flight

¹ Marketing Carrier is PO. Operating Carrier is Aerologic (3S)

² Marketing Carrier is PO. Operating Carrier is Atlas Air (5Y)

³ Marketing Carrier is PO. Operating Carrier is Kalitta Air (K4)

⁴ Marketing Carrier is PO. Operating Carrier is Southern Air (9S)

▲ Indicate aircraft change

RFS available from KIX-NGO/NRT, NGO-KIX/NRT and NRT-KIX/NGO

All times are local time

Schedule is subject to change without prior notice



NRT / NGO - EUR Freighter Schedule

Effective: Oct 27, 2019

NGO/ NRT - Europe	AC Type	DAY								
PO235 / 3S590 ¹ / 3S591 ¹	767F / 777F	D4	<div style="background-color: cyan; padding: 5px; border: 1px solid black;"> NGO D 05:40 </div>	235		<div style="background-color: blue; color: white; padding: 5px; border: 1px solid black;"> NRT A 06:55 / D 08:45 +1 </div>	590	<div style="background-color: orange; padding: 5px; border: 1px solid black;"> HKG A 12:55 +1 / D 17:45 +1 </div>	591	<div style="background-color: lightgreen; padding: 5px; border: 1px solid black;"> LEJ A 23:00 +1 </div>
3S592 ¹ / 3S591 ¹	777F	D1	<div style="background-color: blue; color: white; padding: 5px; border: 1px solid black;"> NRT D 21:30 </div>	590 / 592 / 597		<div style="background-color: orange; padding: 5px; border: 1px solid black;"> HKG A 01:45 +1 / D 17:45 A 14:30 / D 16:45 </div>	591		<div style="background-color: lightgreen; padding: 5px; border: 1px solid black;"> LEJ A 23:00 A 22:00 A 23:00 </div>	
3S590 ¹ / 3S591 ¹	777F	D3	<div style="background-color: blue; color: white; padding: 5px; border: 1px solid black;"> NRT D 09:15 </div>	590 / 592 / 597		<div style="background-color: orange; padding: 5px; border: 1px solid black;"> HKG A 01:45 +1 / D 17:45 A 14:30 / D 16:45 </div>	591		<div style="background-color: lightgreen; padding: 5px; border: 1px solid black;"> LEJ A 23:00 A 22:00 A 23:00 </div>	
3S590 ¹ / 3S591 ¹	777F	D5	<div style="background-color: blue; color: white; padding: 5px; border: 1px solid black;"> NRT D 08:45 </div>	590 / 592 / 597		<div style="background-color: orange; padding: 5px; border: 1px solid black;"> HKG A 01:45 +1 / D 17:45 A 14:30 / D 16:45 </div>	591		<div style="background-color: lightgreen; padding: 5px; border: 1px solid black;"> LEJ A 23:00 A 22:00 A 23:00 </div>	

* Indicate Code Share Flight

¹ Marketing Carrier is PO. Operating Carrier is Aerologic (3S)

² Marketing Carrier is PO. Operating Carrier is Atlas Air (5Y)

³ Marketing Carrier is PO. Operating Carrier is Kalitta Air (K4)

⁴ Marketing Carrier is PO. Operating Carrier is Southern Air (9S)

Indicate aircraft change

RFS available from KIX-NGO/NRT, NGO-KIX/NRT and NRT-KIX/NGO

All times are local time

Schedule is subject to change without prior notice



PVG - USA Freighter Schedule

Effective: Oct 27, 2019

PVG - CVG
FLIGHT

AC Type

DAY

FLIGHT	AC Type	DAY	Origin	Stop	Stop	Destination
PO998	747-8F	D1, 2, 4	PVG D 20:45		ANC A 12:20 / D 13:50	CVG A 00:05 +1
PO998 / 752	744F / 744F	D3	PVG D 20:45	998	ANC A 12:20 / D 13:50	CVG A 00:05 +1 / D 12:35 +1
PO987 / 961	747-8F / 744F	D6	PVG D 05:55	987	ANC A 21:30 -1 / D 23:00 -1	CVG A 09:15 / D 14:55 +1
PO212 / 211 / 214	744F / 747-8F	D2-4	PVG D 04:25	212 NRT A 08:10 / D 21:40	211 NGO A 22:55 / D 02:15+1	214 CVG A 00:30 +1
PO212 / 962	744F / 744F	D6	PVG D 05:00	212 NRT A 08:45 / D 14:25 +1	962 ANC A 03:05 +1 / D 04:35 +1	962 CVG A 14:50 +1
PO228 / 961	747-8F / 744F	D7	PVG D 05:45	228	ANC A 21:20 -1 / D 00:15	CVG A 10:30 / D 14:55
PO212 / 211 / 214 / 961	744F / 744F / 744F	D5	PVG D 04:25	212 NRT A 08:10 / D 22:05	211 NGO A 23:20 / D 03:50 +1	214 CVG A 02:05 +1 / D 14:55 +2

PVG - LAX

5Y538 ²	744F	D2	PVG D 03:40			LAX A 23:15 -1
5Y512 ²	744F	D4	PVG D 03:40			LAX A 23:15 -1
PO718	744F	D3,5	PVG D 03:40			LAX A 23:15 -1
5Y532 ²	744F	D6	PVG D 05:15		ANC A 20:50 -1 / D 22:10 -1	LAX A 04:20
PO718	744F	D7	PVG D 03:40		ANC A 19:15 -1 / D 20:35 -1	LAX A 02:45

* Indicate Code Share Flight

¹ Marketing Carrier is PO. Operating Carrier is Aerologic (3S)

² Marketing Carrier is PO. Operating Carrier is Atlas Air (5Y)

³ Marketing Carrier is PO. Operating Carrier is Kalitta Air (K4)

⁴ Marketing Carrier is PO. Operating Carrier is Southern Air (9S)

▲ Indicate aircraft change

All times are local time

Schedule is subject to change without prior notice



PVG - USA Freighter Schedule (Additional Flights in peak season)

PVG - CVG
FLIGHT

AC Type

DAY

Effective: Oct 27, 2019

PO766

744F

D1

PVG
D 05:00

ANC
A 20:35 -1 / D 22:05 -1

CVG
A 08:20

All times are local time
Schedule is subject to change without prior notice



PVG - Europe Freighter Schedule

Effective: Oct 27, 2019

PVG - Europe	AC Type	DAY		
3S571 ¹	777F	D2,3,4,5,7	PVG 05:50	LEJ 10:45
3S573 ¹	777F	D6	PVG 05:50	FRA 10:50

* Indicate Code Share Flight

¹ Marketing Carrier is PO. Operating Carrier is Aerologic (3S)

² Marketing Carrier is PO. Operating Carrier is Atlas Air (5Y)

³ Marketing Carrier is PO. Operating Carrier is Kalitta Air (K4)

⁴ Marketing Carrier is PO. Operating Carrier is Southern Air (9S)

All times are local time

Schedules are subject to change without notice



SIN - USA Freighter Schedule

SIN - CVG / ORD
FLIGHT

AC Type

DAY

Effective: Oct 27, 2019

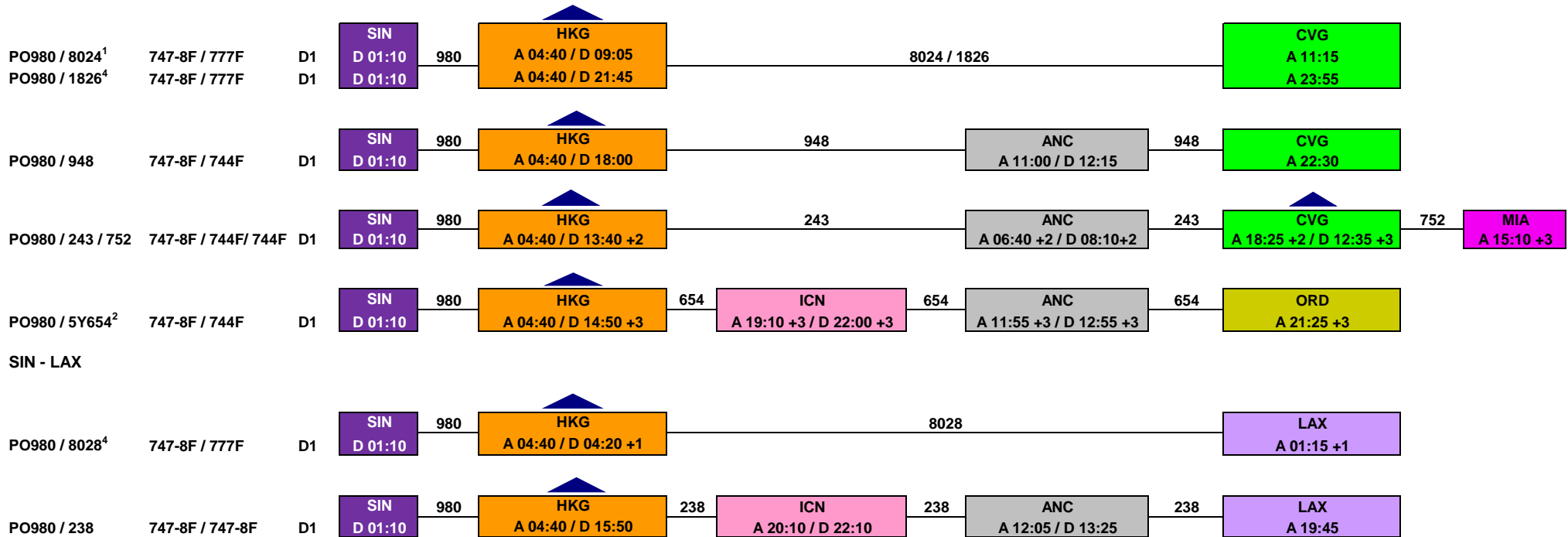

* Indicate Code Share Flight

¹ Marketing Carrier is PO. Operating Carrier is Aerologic (3S)

² Marketing Carrier is PO. Operating Carrier is Atlas Air (5Y)

³ Marketing Carrier is PO. Operating Carrier is Kalitta Air (K4)

⁴ Marketing Carrier is PO. Operating Carrier is Southern Air (9S)

▲ Indicate aircraft change

All times are local time

Schedule is subject to change without prior notice



SYD / MEL - USA Freighter Schedule

Effective: Oct 27, 2019

SYD / MEL - CVG	AC Type	DAY	Schedule Diagram										
PO240 / 211 / 214	767F/ 744F/ 747-8F	D5	SYD D 06:30	240	NRT A 14:45 / D 22:05	211	NGO A 23:20 / D 03:50 +1	214	CVG A 02:05 +1				
PO240 / 962	767F/ 744F	D5	SYD D 06:30	240	NRT A 14:45 / D 14:25 +2	962	ANC A 03:05 +2 / D 04:35 +2	962	CVG A 14:50 +2				
PO246 / 247 / 752	744F	D7	SYD D 22:00	246	MEL A 00:35 +1 / D 01:30 +1	747	SZX A 07:40 +1 / D 02:45 +2	752	NRT A 07:40 +2 / D 09:40 +2	752	ANC A 22:20 +1 / D 23:50 +1	752	CVG A 10:05 +2
SYD / MEL - LAX													
PO748 / 224 / 968	767F/ 747-8F	D4	SYD D 06:30	748	TPE A 13:05 / D 21:00	224	NGO A 00:40+1 / D 02:10 +1	224	ICN A 04:20 +1 / D 08:15 +3	968	ANC A 22:10 +2 / D 01:55 +3	968	LAX A 08:05 +3
PO240 / 717 ² / 718 ²	767F/ 744F	D5	SYD D 06:30	240	NRT A 14:45 / D 08:30 +1	717	ICN A 11:05 +1 / D 00:20 +2	717	PVG A 01:25 +2 / D 03:40 +2	718	ANC A 19:15 +2 / D 20:35 +2	718	LAX A 02:45 +3
PO245 / 716 ²	767F / 744F	D6	SYD D 18:45	245	PVG A 02:30 +1 / D 03:40 +3	716						LAX A 23:15 +2	

* Indicate Code Share Flight

¹ Marketing Carrier is PO. Operating Carrier is Aerologic (3S)

² Marketing Carrier is PO. Operating Carrier is Atlas Air (5Y)

³ Marketing Carrier is PO. Operating Carrier is Kalitta Air (K4)

⁴ Marketing Carrier is PO. Operating Carrier is Southern Air (9S)

▲ Indicate aircraft change

All times are local time

Schedule is subject to change without prior notice



SZX - USA Freighter Schedule

SZX - CVG							Effective: Oct 27, 2019	
FLIGHT	AC Type	DAY						
PO752	744F	D2,5	SZX D 02:45	NRT A 07:50 / D 10:10	ANC A 22:50 -1 / D 00:20 -1	CVG A 10:05		
PO752	744F	D3	SZX D 02:45	NRT A 07:50 / D 09:40	ANC A 22:20 -1 / D 23:50 -1	CVG A 10:05		
PO752	744F	D4	SZX D 02:45	NRT A 07:50 / D 10:10	ANC A 22:50 -1 / D 00:20	CVG A 10:35 / D 12:35	MIA A 15:10	
PO935/962	744F	D7	SZX D 05:30	935 NRT A 10:25 / D 14:25	962 ANC A 03:05 / D 04:35	962 CVG A 14:50		
SZX - LAX								
PO752/238	744F/747-8F	D2	SZX D 02:45	752 NRT A 07:50 / D 10:10	752 ANC A 22:50 -1 / D 13:25	238 LAX A 19:45		
PO752/238	744F/747-8F	D3	SZX D 02:45	752 NRT A 07:50 / D 09:40	752 ANC A 22:20 -1 / D 13:25	238 LAX A 19:45		

SZX trucking to HKG for USA flight connection available. Please refer to HKG-USA Freighter Schedule

▲ Indicate aircraft change

All times are local time

Schedule is subject to change without prior notice



TPE - USA Freighter Schedule

Effective: Oct 27, 2019

TPE - CVG / ORD
FLIGHT

AC Type

DAY

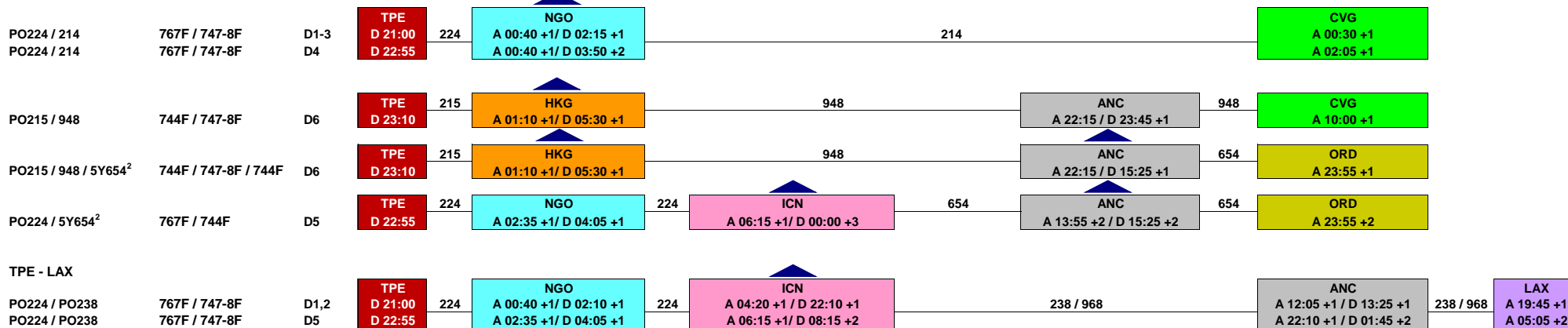

* Indicate Code Share Flight

¹ Marketing Carrier is PO. Operating Carrier is Aerologic (3S)

² Marketing Carrier is PO. Operating Carrier is Atlas Air (5Y)

³ Marketing Carrier is PO. Operating Carrier is Kalitta Air (K4)

⁴ Marketing Carrier is PO. Operating Carrier is Southern Air (9S)

▲ Indicate aircraft change

All times are local time

Schedule is subject to change without prior notice



TPE - Middle East / Europe Freighter Schedule

Effective: Oct 27, 2019

TPE - Middle East / Europe

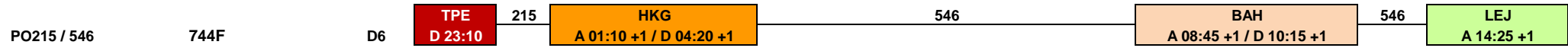

 Indicate aircraft change

All times are local time
Schedule is subject to change without prior notice



Intra-Asia Freighter Schedule

Effective: Oct 27, 2019

FLIGHT	AC Type	DAY				
PO238	747-8F	D1	HKG D 15:50			ICN A 20:10
PO238	747-8F	D2-4	D 16:10			A 20:30
PO968	747-8F	D7	D 01:55			A 06:15
PO750	747-8F	D7	D 17:25			A 21:45
PO238 / 214	747-8F / 747-8F	D1	HKG D 15:50		ICN A 20:10 / D 22:25	NGO A 00:15 +1
PO238 / 214	747-8F / 747-8F	D2-4	D 16:10		A 20:30 / D 22:25	A 00:15 +1
PO968 / 214	747-8F / 747-8F	D7	HKG D 01:55	968	ICN A: 06:15 / D 22:25 +1	NGO A 00:15 +2
PO968 / 989	747-8F / 747-8F	D7	HKG D 01:55	968	ICN A: 06:15 / D 17:05	SIN A 22:45
PO237	744F	D1	ICN D 02:55			HKG A 05:55
PO1875 ⁴	777F	D2	D 05:45			A 08:45
PO237	744F	D3	D 11:45			A 14:45
PO1970 ⁴	777F	D5	D 01:00			A 04:00
PO927	747-8F	D5	D 05:05			A 08:05
PO1245 ⁴	777F	D6	D 05:45			A 00:45
PO214	747-8F	D1-4	ICN D 22:25			NGO A 00:15 +1
PO214	747-8F	D6	D 00:05			A 01:55 +1
PO225 / 224	767F	D2,3	ICN D 05:30	225 / 227	TPE A 07:10 / D 21:00	NGO A 00:40 +1
PO225 / 224	767F	D5	D 05:30		A 07:10 / D 22:55	A 02:35 +1
PO227 / 224	767F	D7	D 05:10		A 06:50 / D 21:00 +1	A 00:40 +2
PO997	747-8F	D2-4	ICN D 05:00			PVG A 06:05
5Y537 ²	744F	D2	ICN D 00:20			PVG A 01:25
PO717	744F	D3,5,7	D 00:20			A 01:25
5Y511 ²	744F	D4	D 00:20			A 01:25
5Y531 ²	744F	D6	D 01:10			A 02:15
PO989	747-8F	D7	ICN D 17:05			SIN A 22:45
PO751	744F	D2	ICN D 21:05			SZX A 00:25 +1
PO225	767F	D2,3,5	ICN D 05:30			TPE A 07:10
PO225	767F	D7	D 05:10			A 06:50

RFS to NRT available



Intra-Asia Freighter Schedule

Effective: Oct 27, 2019

FLIGHT	AC Type	DAY					
PO224 / 1875 ⁴ PO224 / 237	767F / 777F 767F / 744F	D2 D3	<div style="background-color: #00FFFF; padding: 2px;">NGO</div> <div style="background-color: #00FFFF; padding: 2px;">D 02:10</div> <div style="background-color: #00FFFF; padding: 2px;">D 02:10</div>	224	<div style="background-color: #FFB6C1; padding: 2px;">ICN</div> <div style="background-color: #FFB6C1; padding: 2px;">A 04:20 / D 05:45</div> <div style="background-color: #FFB6C1; padding: 2px;">A 04:20 / D 11:45</div>	1875 / 237	<div style="background-color: #FFD700; padding: 2px;">HKG</div> <div style="background-color: #FFD700; padding: 2px;">A 08:45</div> <div style="background-color: #FFD700; padding: 2px;">A 14:45</div>
PO224 PO224	767F 767F	D2,3,5 D6	<div style="background-color: #00FFFF; padding: 2px;">NGO</div> <div style="background-color: #00FFFF; padding: 2px;">D 02:10</div> <div style="background-color: #00FFFF; padding: 2px;">D 04:05</div>				<div style="background-color: #FFB6C1; padding: 2px;">ICN</div> <div style="background-color: #FFB6C1; padding: 2px;">A 04:20</div> <div style="background-color: #FFB6C1; padding: 2px;">A 06:15</div>
PO211 PO211	744F 744F	D2-5 D6	<div style="background-color: #00FFFF; padding: 2px;">NGO</div> <div style="background-color: #00FFFF; padding: 2px;">D 00:30</div> <div style="background-color: #00FFFF; padding: 2px;">D 00:45</div>				<div style="background-color: #FFFF00; padding: 2px;">PVG</div> <div style="background-color: #FFFF00; padding: 2px;">A 02:25</div> <div style="background-color: #FFFF00; padding: 2px;">A 02:40</div>
PO224 / 989	767F / 747-8F	D6	<div style="background-color: #00FFFF; padding: 2px;">NGO</div> <div style="background-color: #00FFFF; padding: 2px;">D 04:05</div>	224	<div style="background-color: #FFB6C1; padding: 2px;">ICN</div> <div style="background-color: #FFB6C1; padding: 2px;">A 06:15 / D 17:00 +1</div>	989	<div style="background-color: #800080; padding: 2px;">SIN</div> <div style="background-color: #800080; padding: 2px;">A 22:40 +1</div>
PO751 PO934	744F 744F	D3,4 D6	<div style="background-color: #00FFFF; padding: 2px;">NGO</div> <div style="background-color: #00FFFF; padding: 2px;">D 21:00</div> <div style="background-color: #00FFFF; padding: 2px;">D 20:45</div>		751		<div style="background-color: #FFFF00; padding: 2px;">SZX</div> <div style="background-color: #FFFF00; padding: 2px;">A 00:30 +1</div> <div style="background-color: #FFFF00; padding: 2px;">A 00:15 +1</div>
PO224 / 225 PO224 / 225	767F 767F	D2,3,5 D6	<div style="background-color: #00FFFF; padding: 2px;">NGO</div> <div style="background-color: #00FFFF; padding: 2px;">D 02:10</div> <div style="background-color: #00FFFF; padding: 2px;">D 04:05</div>	224	<div style="background-color: #FFB6C1; padding: 2px;">ICN</div> <div style="background-color: #FFB6C1; padding: 2px;">A 04:20 / D 05:30</div> <div style="background-color: #FFB6C1; padding: 2px;">A 06:15 / D 05:10 +1</div>	225	<div style="background-color: #8B0000; padding: 2px;">TPE</div> <div style="background-color: #8B0000; padding: 2px;">A 07:10</div> <div style="background-color: #8B0000; padding: 2px;">A 06:50 +1</div>
3S592 ¹ 3S590 ¹ 3S590 ¹ 3S597 ¹	777F 777F 777F 777F	D1 D3 D5 D7	<div style="background-color: #0000FF; padding: 2px;">NRT</div> <div style="background-color: #0000FF; padding: 2px;">D 21:30</div> <div style="background-color: #0000FF; padding: 2px;">D 10:15</div> <div style="background-color: #0000FF; padding: 2px;">D 08:45</div> <div style="background-color: #0000FF; padding: 2px;">D 22:35</div>				<div style="background-color: #FFD700; padding: 2px;">HKG</div> <div style="background-color: #FFD700; padding: 2px;">A 01:45 +1</div> <div style="background-color: #FFD700; padding: 2px;">A 14:30</div> <div style="background-color: #FFD700; padding: 2px;">A 12:55</div> <div style="background-color: #FFD700; padding: 2px;">A 02:50 +1</div>
PO213 / 237 PO213 / 1970 ⁴ PO213 / 927 5Y217 ² / 237	747-8F / 744F 744F / 777F 747-8F / 747-8F 744F / 744F	D1 D4 D4 D7	<div style="background-color: #0000FF; padding: 2px;">NRT</div> <div style="background-color: #0000FF; padding: 2px;">D 21:40</div> <div style="background-color: #0000FF; padding: 2px;">D 10:10</div> <div style="background-color: #0000FF; padding: 2px;">D 10:10</div> <div style="background-color: #0000FF; padding: 2px;">D 13:25</div>	213 / 232	<div style="background-color: #FFB6C1; padding: 2px;">ICN</div> <div style="background-color: #FFB6C1; padding: 2px;">A 00:15 +1 / D 05:45 +1</div> <div style="background-color: #FFB6C1; padding: 2px;">A 12:45 / D 01:00 +1</div> <div style="background-color: #FFB6C1; padding: 2px;">A 12:45 / D 05:05 +1</div> <div style="background-color: #FFB6C1; padding: 2px;">A 16:05 / D 02:55 +1</div>	237	<div style="background-color: #FFD700; padding: 2px;">HKG</div> <div style="background-color: #FFD700; padding: 2px;">A 08:45 +1</div> <div style="background-color: #FFD700; padding: 2px;">A 04:00 +1</div> <div style="background-color: #FFD700; padding: 2px;">A 08:05 +1</div> <div style="background-color: #FFD700; padding: 2px;">A 05:45 +1</div>
PO213 PO213 5Y217 ²	747-8F 747-8F 744F	D1 D3-5 D7	<div style="background-color: #0000FF; padding: 2px;">NRT</div> <div style="background-color: #0000FF; padding: 2px;">D 21:40</div> <div style="background-color: #0000FF; padding: 2px;">D 10:10</div> <div style="background-color: #0000FF; padding: 2px;">D 13:25</div>				<div style="background-color: #FFB6C1; padding: 2px;">ICN</div> <div style="background-color: #FFB6C1; padding: 2px;">A 00:15 +1</div> <div style="background-color: #FFB6C1; padding: 2px;">A 12:45</div> <div style="background-color: #FFB6C1; padding: 2px;">A 16:05</div>



Intra-Asia Freighter Schedule

Effective: Oct 27, 2019

FLIGHT	AC Type	DAY					
PO213 PO958	747-8F 747-8F	D6 D7	NRT D 22:05 D 21:45			PVG A 00:35 +1 A 00:15 +1	
PO213 / 997	747-8F	D1	NRT D 21:40	213	ICN A 00:15 +1 / D 05:00 +1	997 PVG A 06:05 +1	
PO213 / 997	744F / 747-8F	D3	NRT D 10:10	213	ICN A 12:45 / D 05:00 +1	997 PVG A 06:05 +1	
5Y511 ² 5Y531 ² PO717 ²	744F 744F 744F	D3 D5 D4,6	NRT D 08:30 D 08:30 D 08:30		ICN A 11:05 / D 00:20 +1 A 11:05 / D 01:10 +1 A 11:05 / D 00:20 +1	PVG A 01:25 +1 A 02:15 +1 A 01:25 +1	
PO211 PO211 PO211	744F 744F 744F	D1 D2-4 D5	NRT D 21:45 D 21:40 D 22:05		NGO A 23:00 / D 00:30 +1 A 22:55 / D 00:30 +1 A 23:20 / D 00:45 +1	PVG A 02:25 +1 A 02:25 +1 A 02:40 +1	
PO213 / 989	747-8F / 747-8F	D5	NRT D 10:10	213	ICN A 12:45 / D 17:00 +2	989 SIN A 21:00 +2	
PO213 / 751	747-8F / 744F	D1	NRT D 21:40		ICN A 00:15 +1 / D 21:05 +1	SZX A 00:15 +2	
PO211 / 751 PO211 / 934	744F / 744F 744F / 744F	D2,3 D5	NRT D 21:40 D 22:05	211	NGO A 22:55 / D 21:00 +1 A 23:20 / D 21:45 +1	751 / 934 SZX A 00:30 +2 A 00:15 +2	
PO215	744F	D6	NRT D 17:50			TPE A 21:00	
PO213 / 225 PO717 ² / PO225 PO213 / 225 5Y531 ² / PO225 PO213 / 225 5Y217 ² / PO225	747-8F / 767F 744F / 767F 747-8F / 767F 744F / 767F 747-8F / 767F 744F / 767F	D1 D4 D4 D5 D5 D7	NRT D 21:40 D 08:30 D 10:10 D 08:30 D 10:10 D 13:25	213 / 717 / 531 / 232 / 217	ICN A 00:15 +1 / D 05:30 +1 A 11:05 / D 05:30 +1 A 12:45 / D 05:30 +1 A 11:05 / D 05:10 +2 A 12:45 / D 05:10 +2 A 16:05 / D 05:30 +2	225 TPE A 07:10 +1 A 07:10 +1 A 07:10 +1 A 06:50 +2 A 06:50 +2 A 07:10 +2	
PO211 / 224 / 225 PO211 / 224 / 225 PO211 / 224 / 225	744F / 767F 744F / 767F 744F / 767F	D1 D2,4 D5	NRT D 21:45 D 21:40 D 22:05	211	NGO A 23:00 / D 02:10 +1 A 22:55 / D 02:10 +1 A 23:20 / D 04:05 +1	224 ICN A 04:20 +1 / D 05:30 +1 A 04:20 +1 / D 05:30 +1 A 06:15 +1 / D 07:55 +1	225 TPE A 07:10 +1 A 07:10 +1 A 09:35 +1



Intra-Asia Freighter Schedule

Effective: Oct 27, 2019

FLIGHT	AC Type	DAY							
PO212 / 213	744F / 747-8F	D3,4,5	PVG D 04:25	212	NRT A 08:00 / D 10:10	213	ICN A 12:45		
PO212 / 211 / 224	744F / 767F	D2, 4	PVG D 04:25	212	NRT A 08:00 / D 21:40	211	NGO A 22:55 / D 02:10 +1	224	ICN A 04:20 +1
PO212 / 211 / 224	744F / 767F	D5	PVG D 04:25		NRT A 08:00 / D 22:05		NGO A 23:25 / D 04:05 +1		ICN A 06:15 +1
PO212 / 211	744F / 744F	D2, 4	PVG D 04:25		NRT A 08:00 / D 21:45		NGO A 22:55		
PO212 / 211	744F / 744F	D3	PVG D 04:25	212	NRT A 08:00 / D 21:40	211	NGO A 22:50		
PO212 / 211	744F / 744F	D5	PVG D 04:25		NRT A 08:00 / D 22:05		NGO A 23:15		
PO212	744F	D2-5	PVG D 04:25				NRT A 22:55		
PO212	744F	D6	PVG D 05:00				NRT A 08:00		
PO212	744F	D6	PVG D 05:00				NRT A 08:35		
PO212 / 213 / 989	744F / 747-8F / 747-8F	D5	PVG D 04:25	212	NRT A 08:00 / D 10:10	213	ICN A 12:45 / D 17:05 +2	989	SIN A 22:45 +2
PO752 / 213	744F / 747-8F	D3,4,5	SZX D 02:45	752 / 935	NRT A 07:40 / D 10:10	213	ICN A 12:45		
PO935 / 213	744F / 747-8F	D7	SZX D 05:30		NRT A 10:25 / D 21:40 +1		ICN A 00:15 +2		
PO752 / 211	744F / 744F	D2-4	SZX D 02:45	752 / 935	NRT A 07:40 / D 21:40	211	NGO A 22:55		
PO752 / 211	744F / 744F	D5	SZX D 02:45		NRT A 07:40 / D 22:05		NGO A 23:20		
PO935 / 211	744F / 744F	D7	SZX D 05:30		NRT A 10:25 / D 21:40 +1		NGO A 00:15 +1		
PO752	744F	D2-5	SZX D 02:45				NRT A 07:40		
PO935	744F	D7	SZX D 05:30				NRT A 10:25		
PO752 / 213 / 989	744F / 747-8F / 744F	D5	SZX D 02:45	212	NRT A 07:40 / D 10:10	213	ICN A 12:45 / D 17:00 +2	989	SIN A 22:40 +2



Intra-Asia Freighter Schedule

Effective: Oct 27, 2019

FLIGHT	AC Type	DAY	Schedule Details			
PO224 PO224	767F 767F	D1,2,4 D5	TPE D 21:00 D 22:55	NGO A 00:40 +1 / D 02:10 +1 A 02:35 +1 / D 04:05 +1	ICN A 04:20 +1 A 06:15 +1	
PO224 PO224	767F 767F	D1-4 D5	TPE D 21:00 D 22:55		NGO A 00:40 +1 A 02:35 +1	
PO224 / 235	767F	D3	TPE D 21:00	224 NGO A 00:40 +1 / D 05:40 +1	235 NRT A 06:55 +1	
PO224 / 213 / 989	767F / 747-8F / 747-8F	D5	TPE D 22:55	224 NGO A 02:35 +1 / D 04:05 +1	224 ICN A 06:15 +1 / D 17:00 +2	989 SIN A 22:40 +2
PO980	747-8F	D1	SIN D 00:55		HKG A 04:55	
PO980 / 238	747-8F / 747-8F	D1	SIN D 00:55	980 HKG A 04:55 / D 15:50	238 ICN A 20:10	
PO980 / 238 / 214	747-8F / 747-8F / 747-8F	D1	SIN D 00:55	980 HKG A 04:55 / D 15:50	238 ICN A 20:10 / D 22:25	214 NGO A 00:15 +1

From NGO, RFS is available to KIX and NRT

* Indicate Code Share Flight

¹ Marketing Carrier is PO. Operating Carrier is Aerologic (3S)

² Marketing Carrier is PO. Operating Carrier is Atlas Air (5Y)

³ Marketing Carrier is PO. Operating Carrier is Kalitta Air (K4)

⁴ Marketing Carrier is PO. Operating Carrier is Southern Air (9S)

▲ Indicate aircraft change

All times are local time

Schedule is subject to change without prior notice



Asia - SYD / MEL Freighter Schedule

Effective: Oct 27, 2019

FLIGHT	AC Type	DAY											
HKG - SYD													
PO238 / 214 / truck / 241	747-8F / 747-8F / truck / 767F	D1	HKG D 15:50	238	ICN A 20:10 / D 22:25	214	NGO A 00:15 +1 / D 21:00 +1	Truck	NRT A 06:00 +2 / D 09:50 +2	241	SYD A 21:50 +2		
PO238 / 214 / truck / 241	747-8F / 747-8F / truck / 767F	D2	HKG D 16:10		ICN A 20:30 / D 22:25		NGO A 00:15 +1 / D 21:00 +1		NRT A 06:00 +2 / D 09:50 +2		SYD A 21:50 +2		
PO238 / 214 / truck / 241	747-8F / 747-8F / truck / 767F	D3	HKG D 16:10		ICN A 20:30 / D 22:25		NGO A 00:15 +1 / D 21:00 +1		NRT A 06:00 +2 / D 19:00 +2		SYD A 07:00 +3		
ICN - SYD													
PO214 / truck / 241	747-8F / truck / 767F	D1,2	ICN D 22:25	214	NGO A 00:15 +1 / D 21:00 +1	Truck	NRT A 06:00 +2 / D 09:50 +2			241	SYD A 21:50 +2		
PO214 / truck / 241	747-8F / truck / 767F	D3	ICN D 22:25		NGO A 00:15 +1 / D 21:00 +1		NRT A 06:00 +2 / D 19:00 +2				SYD A 07:00 +3		
NGO-SYD													
Truck / PO241	Truck / 767F	D2,3	NGO D 21:00	Truck	NRT A 06:00 +1 / D 09:50 +1					241	SYD A 21:50 +1		
Truck / PO241	Truck / 767F	D4	NGO D 21:00		NRT A 06:00 +1 / D 19:00 +1						SYD A 07:00 +2		
NRT - SYD													
PO241	767F	D3,4	NRT D 09:50							241	SYD A 21:50		
PO241	767F	D5	NRT D 19:00								SYD A 07:00 +1		
PVG - SYD													
PO212 / 241	744F / 767F	D3,4	PVG D 04:25	212	NRT A 08:10 / D 09:50					241	SYD A 21:50		
PO212 / 241	744F / 767F	D5	PVG D 04:25		NRT A 08:10 / D 19:00						SYD A 07:00 +1		
TPE - SYD													
PO224 / truck / 241	767F / truck / 767F	D1,2	TPE A 21:00	224	NGO A 00:40 +1 / D 21:00 +1	Truck	NRT A 06:00 +2 / D 09:50 +2			241	SYD A 21:50 +2		
PO224 / truck / 241	767F / truck / 767F	D3	TPE A 21:00		NGO A 00:40 +1 / D 21:00 +1		NRT A 06:00 +2 / D 19:00 +2				SYD A 07:00 +3		
SIN - SYD													
PO224 / truck / 241	767F / truck / 767F	D7	SIN D 01:10	980	HKG A 04:40 / D 15:50	238	ICN A 20:10 / D 22:25	214	NGO A 00:15 +1 / D 21:00 +1	Truck	NRT A 06:00 +2 / D 09:50	241	SYD A 07:00 +3

MEL destination cargo can be moved from SYD via truck or can connect PO246 SYD-MEL on D7

* Indicate Code Share Flight

¹ Marketing Carrier is PO. Operating Carrier is Aerologic (3S)

² Marketing Carrier is PO. Operating Carrier is Atlas Air (5Y)

³ Marketing Carrier is PO. Operating Carrier is Kalitta Air (K4)

⁴ Marketing Carrier is PO. Operating Carrier is Southern Air (9S)

▲ Indicate aircraft change

All times are local time

Schedule is subject to change without prior notice



SYD / MEL - Asia Freighter Schedule

Effective: Oct 27, 2019

FLIGHT SYD - ICN	AC Type	DAY							
PO240 / 717 ²	767F/744F	D5	SYD D 06:30	240	NRT A 14:45 / D 08:30 +1	717	ICN A 11:05 +1		
PO240 / 211 / 224	767F/744F/767F	D5	SYD D 06:30	240	NRT A 14:45 / D 22:05	211	NGO A 23:20 +1 / D 04:05 +2	224	ICN A 06:15 +2
SYD - HKG									
PO240 / 717 ² / 1237 ⁴	767F/744F / 744F	D5	SYD D 06:30	240	NRT A 14:45 / D 08:30 +1	717	ICN A 11:05 +1 / D 16:05 +1	1237	HKG A 19:05 +1
PO240 / 3S597 ¹	767F/777F	D5	SYD D 06:30	240	NRT A 14:45 / D 22:35 +2	597	HKG A 02:50 +3		
SYD - NGO									
PO240 / 211	767F/744F	D5	SYD D 06:30	240	NRT A 14:45 / D 22:05	211	NGO A 23:20		
SYD / MEL - NRT									
PO240	767F	D5	SYD D 06:30	240					NRT A 14:45
PO246 / 747 / 752	744F	D7	SYD D 22:00	246	MEL A 23:35 / D 01:30 +1	747	SZX A 07:50 +1 / D 02:45 +2	752	NRT A 07:40 +2



SYD / MEL - Asia Freighter Schedule

Effective: Oct 27, 2019

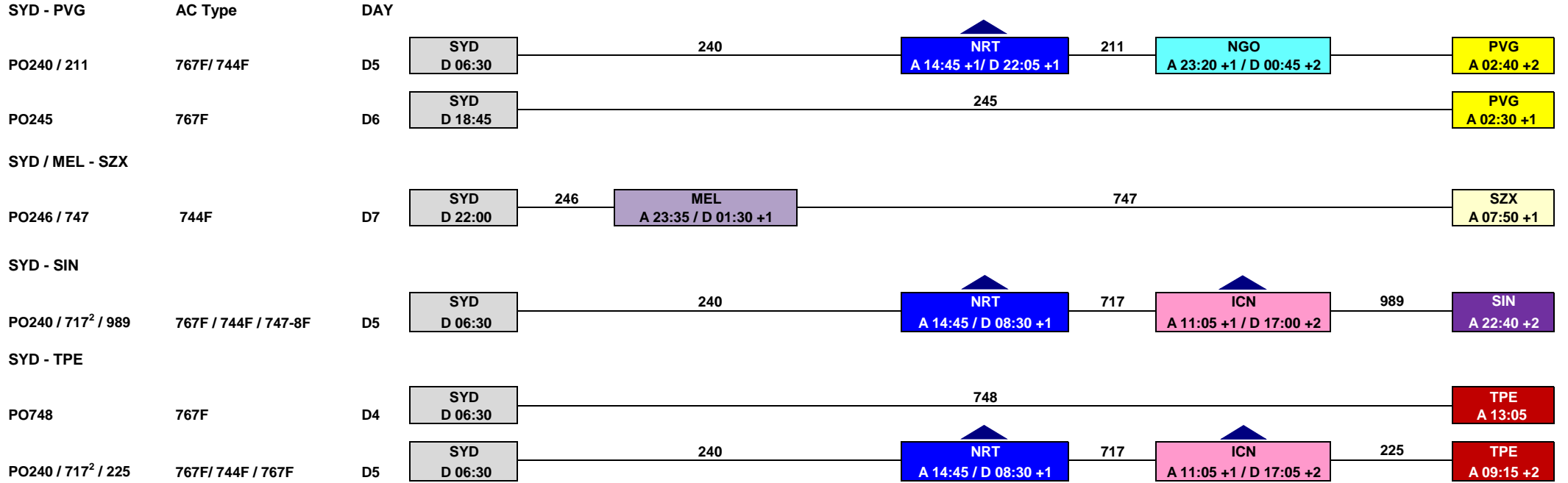

* Indicate Code Share Flight

¹ Marketing Carrier is PO. Operating Carrier is Aerologic (3S)

² Marketing Carrier is PO. Operating Carrier is Atlas Air (5Y)

³ Marketing Carrier is PO. Operating Carrier is Kalitta Air (K4)

⁴ Marketing Carrier is PO. Operating Carrier is Southern Air (9S)

 Indicate aircraft change

All times are local time

Schedule is subject to change without prior notice



CVG - Asia / SYD Freighter Schedule

Effective: Oct 27, 2019

FLIGHT	AC Type	DAY	CVG to Asia			
PO947 PO947 PO8990 ³	747-8F 747-8F 744F	D2,3,4 D5 D7	CVG D 04:20 D 06:45 D 16:00	ANC A 07:25 / D 08:55 A 09:50 / D 14:05 A 19:05 / D 20:35		HKG A 13:30 +1 A 18:40 +1 A 01:10 +2
PO8992 ³ PO8992 ³	744F 744F	D1 D6	CVG D 10:00 D 10:00		NGO A 14:10 +1 / D 04:00 +2 A 14:10 +1 / D 05:20 +2	HKG A 07:30 +2 A 08:50 +2
PO749	747-8F	D6	CVG D 05:00		NRT A 08:40 +1 / D 10:00 +1	HKG A 14:05 +1
PO913 ⁴ PO237 PO1837 ⁴ PO1237 ⁴ PO237 PO1835 ⁴ PO1875 ⁴	777F 744F 777F 777F 744F 777F 777F	D1 D2,4 D3 D5 D6 D7 D7	CVG D 18:20 D 05:45 D 05:45 D 09:30 D 20:30 D 17:50 D 23:15		ICN A 23:00 +1 / D 01:00 +2 A 10:25 +1 / D 11:45 +1 A 10:25 +1 / D 11:55 +1 A 14:10 +1 / D 16:05 +1 A 01:00 +2 / D 02:55 +2 A 22:30 +1 / D 00:05 +2 A 03:55 +2 / D 05:45 +2	HKG A 04:00 +2 A 14:45 +1 A 14:55 +1 A 19:05 +1 A 05:55 +2 A 03:05 +2 A 08:45 +2
PO213	747-8F	D2,3,4	CVG D 04:35		NRT A 08:15 +1 / D 10:10 +1	ICN A 12:45 +1
PO213 / 211 PO213 / 211	747-8F / 744F 747-8F / 744F	D2,3 D4	CVG D 04:35 D 04:35	213	NRT A 08:15 +1 / D 21:40 +1 A 08:15 +1 / D 22:05 +1	NGO D 22:55 +1 D 23:20 +1
PO213 PO958	747-8F 747-8F	D5 D6	CVG D 07:05 D 16:05		NRT A 10:45 +1 / D 22:05 +1 A 19:45 +1 / D 21:45 +1	PVG A 00:35 +2 A 00:15 +2



CVG - Asia / SYD Freighter Schedule

Effective: Oct 27, 2019

FLIGHT	AC Type	DAY	CVG to Asia						
PO213 / 997	747-8F	D7	CVG D 16:35	213	NRT A 20:15 +1 / D 21:40 +1	213	ICN A 00:15 +2 / D 05:00 +2	997	PVG A 06:05 +2
PO989	747-8F	D6	CVG D 07:40		ANC A 10:45 / D 12:15		ICN A 15:00 +1 / D 17:00 +1		SIN A 22:40 +1
PO751	744F	D1	CVG D 04:20		ANC A 07:25 / D 09:05		ICN A 11:50 +1 / D 21:05 +1		SZX A 00:15 +2
PO1837 ⁴ / 225	777F / 767F	D3	CVG D 05:45	1837 / 1237 / 1835			ICN A 10:25 +1 / D 05:30 +2	225	TPE A 07:10 +2
PO1237 ⁴ / 225	777F / 767F	D5	CVG D 09:30				ICN A 14:10 +1 / D 05:10 +2		TPE A 06:50 +2
PO1835 ⁴ / 225	777F / 767F	D7	CVG D 17:50				ICN A 22:30 +1 / D 05:30 +2		TPE A 07:10 +2
PO751 / 225	744F / 767F	D1	CVG D 04:20	751	ANC A 07:25 / D 09:05	751	ICN A 11:50 +1 / D 05:30 +2	225	TPE A 07:10 +2
PO213 / 241	747-8F / 767F	D2,3	CVG D 04:35	213			NRT A 08:15 +1 / D 09:50 +1	241	SYD A 21:50 +1
PO213 / 241	747-8F / 767F	D4	CVG D 04:35				NRT A 08:15 +1 / D 19:00 +1		SYD A 07:00 +2
PO751	744F	D2,3	CVG D 15:15	751			NGO A 19:00 +1 / D 21:00 +1	751 / 934	SZX A 00:30 +2
PO751 / 934	744F	D5	CVG D 15:00				NGO A 18:45 +1 / D 20:45 +1		SZX A 00:15 +2
PO246	744F	D6	CVG D 06:30		HNL A 11:10 / D 12:40		SYD A 19:50 +1 / D 22:00 +1		MEL A 23:35 +1

* Indicate Code Share Flight

¹ Marketing Carrier is PO. Operating Carrier is Aerologic (3S)

² Marketing Carrier is PO. Operating Carrier is Atlas Air (5Y)

³ Marketing Carrier is PO. Operating Carrier is Kalitta Air (K4)

⁴ Marketing Carrier is PO. Operating Carrier is Southern Air (9S)

▲ Indicate flight changes

All times are local time

Schedule is subject to change without prior notice



LAX - Asia / SYD Freighter Schedule

Effective: Oct 27, 2019

FLIGHT	AC Type	DAY	LAX to Asia
PO927	747-8F	D3	<div style="display: flex; align-items: center;"> <div style="border: 1px solid black; padding: 2px; margin-right: 10px;">LAX D 21:45</div> <div style="flex-grow: 1; border-bottom: 1px solid black; position: relative;"> 997 </div> <div style="border: 1px solid black; padding: 2px; margin-right: 10px;">ICN A 03:35 +2 / D 05:05 +2</div> <div style="border-bottom: 1px solid black; position: relative;"> 214 </div> <div style="border: 1px solid black; padding: 2px;">HKG A 08:05 +2</div> </div>
PO997	747-8F	D7	<div style="display: flex; align-items: center;"> <div style="border: 1px solid black; padding: 2px; margin-right: 10px;">LAX D 21:40</div> <div style="flex-grow: 1; border-bottom: 1px solid black; position: relative;"> 997 </div> <div style="border: 1px solid black; padding: 2px; margin-right: 10px;">ICN A 03:35 +2 / D 05:00 +2</div> <div style="border-bottom: 1px solid black; position: relative;"> 214 </div> <div style="border: 1px solid black; padding: 2px;">ICN A 03:30 +2</div> </div>
PO997	747-8F	D4	<div style="display: flex; align-items: center;"> <div style="border: 1px solid black; padding: 2px; margin-right: 10px;">LAX D 21:45</div> <div style="flex-grow: 1; border-bottom: 1px solid black; position: relative;"> 997 </div> <div style="border: 1px solid black; padding: 2px; margin-right: 10px;">ICN A 03:35 +2 / D 05:00 +2</div> <div style="border-bottom: 1px solid black; position: relative;"> 214 </div> <div style="border: 1px solid black; padding: 2px;">PVG A 03:45 +2</div> </div>
PO997	747-8F	D1,2	<div style="display: flex; align-items: center;"> <div style="border: 1px solid black; padding: 2px; margin-right: 10px;">LAX D 21:45</div> <div style="flex-grow: 1; border-bottom: 1px solid black; position: relative;"> 997 </div> <div style="border: 1px solid black; padding: 2px; margin-right: 10px;">ICN A 03:35 +2 / D 05:00 +2</div> <div style="border-bottom: 1px solid black; position: relative;"> 214 </div> <div style="border: 1px solid black; padding: 2px;">PVG A 06:05 +2</div> </div>
PO997 / 214	747-8F / 747-8F	D1,2	<div style="display: flex; align-items: center;"> <div style="border: 1px solid black; padding: 2px; margin-right: 10px;">LAX D 21:45</div> <div style="flex-grow: 1; border-bottom: 1px solid black; position: relative;"> 997 </div> <div style="border: 1px solid black; padding: 2px; margin-right: 10px;">ICN A 03:35 +2 / D 22:25 +2</div> <div style="border-bottom: 1px solid black; position: relative;"> 214 </div> <div style="border: 1px solid black; padding: 2px;">NGO A 00:15 +3</div> </div>
PO997/214	747-8F / 747-8F	D7	<div style="display: flex; align-items: center;"> <div style="border: 1px solid black; padding: 2px; margin-right: 10px;">LAX D 21:40</div> <div style="flex-grow: 1; border-bottom: 1px solid black; position: relative;"> 997 </div> <div style="border: 1px solid black; padding: 2px; margin-right: 10px;">ICN A 03:30 +2 / D 22:25 +2</div> <div style="border-bottom: 1px solid black; position: relative;"> 214 </div> <div style="border: 1px solid black; padding: 2px;">NGO A 00:15 +3</div> </div>
PO927 / 989	747-8F / 747-8F	D3	<div style="display: flex; align-items: center;"> <div style="border: 1px solid black; padding: 2px; margin-right: 10px;">LAX D 21:45</div> <div style="flex-grow: 1; border-bottom: 1px solid black; position: relative;"> 927 </div> <div style="border: 1px solid black; padding: 2px; margin-right: 10px;">ICN A 03:35 +2 / D 17:00 +4</div> <div style="border-bottom: 1px solid black; position: relative;"> 989 </div> <div style="border: 1px solid black; padding: 2px;">SIN A 22:40 +4</div> </div>
PO997 / 751	747-8F / 744F	D7	<div style="display: flex; align-items: center;"> <div style="border: 1px solid black; padding: 2px; margin-right: 10px;">LAX D 21:40</div> <div style="flex-grow: 1; border-bottom: 1px solid black; position: relative;"> 997 </div> <div style="border: 1px solid black; padding: 2px; margin-right: 10px;">ICN A 03:30 +2 / D 21:05 +2</div> <div style="border-bottom: 1px solid black; position: relative;"> 751 </div> <div style="border: 1px solid black; padding: 2px;">SZX A 00:25 +3</div> </div>
PO997 / 214 / 751	747-8F / 747-8F / 744F	D1	<div style="display: flex; align-items: center;"> <div style="border: 1px solid black; padding: 2px; margin-right: 10px;">LAX D 21:45</div> <div style="flex-grow: 1; border-bottom: 1px solid black; position: relative;"> 997 </div> <div style="border: 1px solid black; padding: 2px; margin-right: 10px;">ICN A 03:35 +2 / D 22:25 +2</div> <div style="border-bottom: 1px solid black; position: relative;"> 214 </div> <div style="border: 1px solid black; padding: 2px; margin-right: 10px;">NGO A 00:15 +3 / D 21:00 +3</div> <div style="border-bottom: 1px solid black; position: relative;"> 751 </div> <div style="border: 1px solid black; padding: 2px;">SZX A 00:30 +4</div> </div>



LAX - Asia / SYD Freighter Schedule

Effective: Oct 27, 2019

FLIGHT	AC Type	DAY	LAX to Asia				
PO927 / 225	747-8F / 767F	D3	LAX D 21:45	927		ICN A 03:35 +2 / D 05:30 +2	225 TPE A 07:10 +2
PO997 / 225	747-8F / 767F	D7	LAX D 21:40	997		ICN A 03:30 +2 / D 05:30 +2	225 TPE A 07:10 +2
5Y511 ² / 241	744F / 767F	D2	LAX D 01:35	511		NRT A 06:30 +1 / D 09:50 +1	241 SYD A 21:50 +1
5Y531 ² / 241 / 246	744F / 767F / 744F	D4	LAX D 01:35	511	NRT A 06:30 +1 / D 19:00 +1	241 SYD A 07:00 +2 / D 22:00 +3	246 MEL A 23:35 +3
5Y511 ²	744F	D2	LAX D 01:35		NRT A 06:30 +1 / D 08:30 +1	ICN A 11:05 +1 / D 00:20 +2	PVG A 01:25 +2
PO717	744F	D3, 5	LAX D 01:35		NRT A 06:30 +1 / D 08:30 +1	ICN A 11:05 +1 / D 00:20 +2	PVG A 01:25 +2
5Y531 ²	744F	D4	LAX D 01:35		NRT A 06:30 +1 / D 08:30 +1	ICN A 11:05 +1 / D 01:10 +2	PVG A 02:15 +2
5Y217 ²	744F	D6	LAX D 06:35		NRT A 11:30 +1 / D 13:25 +1	ICN A 16:05 +1	

* Indicate Code Share Flight

¹ Marketing Carrier is PO. Operating Carrier is Aerologic (3S)

² Marketing Carrier is PO. Operating Carrier is Atlas Air (5Y)

³ Marketing Carrier is PO. Operating Carrier is Kalitta Air (K4)

⁴ Marketing Carrier is PO. Operating Carrier is Southern Air (9S)

▲ Indicate flight changes

All times are local time

Schedule is subject to change without prior notice



JFK - Asia / SYD Freighter Schedule

Effective: Oct 27, 2019

FLIGHT	AC Type	DAY	JFK to Asia						
PO1876 ⁴ / 1241 ⁴ PO914 ⁴ / 1970 ⁴ PO1876 ⁴ / 1245 ⁴ PO914 ⁴ / 1243 ⁴	777F 777F 777F 777F	D2	JFK D 13:25	1876 / 914	ORD A 14:55 / D 17:50	1241 / 1970 / 1245 / 1243	ICN A 23:05 +1 / D 01:05 +2	1970 / 1245 /	HKG A 04:05 +2
		D3	JFK D 13:25		ORD A 14:55 / D 17:45		ICN A 23:00 +1 / D 01:00 +2		HKG A 04:00 +2
		D4	JFK D 13:25		ORD A 14:55 / D 22:40		ICN A 03:55 +2 / D 05:45 +2		HKG A 08:45 +2
		D5	JFK D 13:25		ORD A 14:55 / D 20:45		ICN A 02:00 +2 / D 04:00 +2		HKG A 07:00 +2
PO1876 ⁴ / 1875 ⁴	777F	D7	JFK D 13:25	1876	CVG A 15:45 / D 23:15	1875	ICN A 03:55 +2 / D 05:45 +2	1875	HKG A 08:45 +2
PO1876 ⁴ / 1875 ⁴ / 997	777F / 747-8F	D7	JFK D 13:25	1876	CVG A 15:45 / D 23:15	1875	ICN A 03:35 +2 / D 05:00 +3	997	PVG A 06:05 +3
PO1876 ⁴ / 1241 ⁴ / 5Y511 ² PO914 ⁴ / 1970 ⁴ / 217 ²	777F / 744F 777F / 744F	D2	JFK D 13:25	1876 / 914	ORD A 14:55 / D 17:50	1241 / 1970	ICN A 23:05 +1 / D 00:20 +2	511 / 217	PVG A 01:25 +2
		D3	JFK D 13:25		ORD A 14:55 / D 17:45		ICN A 23:00 +1 / D 00:20 +2		
PO1876 ⁴ / 1241 ⁴ / 214 PO914 ⁴ / 1970 ⁴ / 214	777F / 747-8F 777F / 747-8F	D2	JFK D 13:25	1876 / 914	ORD A 14:55 / D 17:50	1241 / 1970	ICN A 23:05 +1 / D 22:25 +2	214	NGO A 00:15 +3
		D3	JFK D 13:25		ORD A 14:55 / D 17:45		ICN A 23:00 +1 / D 00:05 +3		
PO1876 ⁴ / 213	777F / 747-8F	D7	JFK D 13:25	1876	CVG A 15:45 / D 04:35 +2	213			NRT A 08:15 +3
PO914 ⁴ / 1243 ⁴ / 989	777F / 747-8F	D5	JFK D 13:25	1876	ORD A 14:55 / D 20:45	1875	ICN A 02:00 +2 / D 17:00 +2	989	SIN A 22:40 +2
PO1876 ⁴ / 1875 ⁴ / 751	777F / 744F	D7	JFK D 13:25	1876	CVG A 15:45 / D 23:15	1875	ICN A 03:35 +2 / D 21:05 +3	751	SZX A 00:25 +4
PO914 ⁴ / 1970 ⁴ / 225 PO914 ⁴ / 1243 ⁴ / 225	777F / 767F 777F / 767F	D3	JFK D 13:25	1876 / 914	ORD A 14:55 / D 17:45	1970 / 1243	ICN A 23:00 +1 / D 05:30 +2	225	TPE A 07:10 +2
		D5	JFK D 13:25		ORD A 14:55 / D 20:45		ICN A 02:00 +2 / D 05:10 +2		
PO1876 ⁴ / 213 / 241	777F / 747-8F / 767F	D7	JFK D 13:25	1876	CVG A 15:45 / D 04:35 +2	213	NRT A 08:15 +3 / D 09:50 +4	241	SYD A 21:50 +4



ORD - Asia / SYD Freighter Schedule

Effective: Oct 27, 2019

FLIGHT	AC Type	DAY	ORD to Asia								
PO1241 ⁴ PO1970 ⁴ PO1245 ⁴ PO1243 ⁴	777F 777F 777F 777F	D2 D3 D4 D5	ORD D 17:50 D 17:45 D 22:40 D 20:45	1241 / 1970 / 1245 / 1243	ICN A 23:05 +1 / D 01:05 +2 A 23:00 +1 / D 01:00 +2 A 03:55 +2 / D 05:45 +2 A 02:00 +2 / D 04:00 +2	1241 / 1970 / 1245 / 1243	HKG A 04:05 +2 A 04:00 +2 A 08:45 +2 A 07:00 +2				
1241 ⁴ / 5Y511 ² 1970 ⁴ / 217 ²	777F / 744F 777F / 744F	D2 D3	ORD D 17:50 D 17:45	1241 / 1970	ICN A 23:05 +1 / D 00:20 +2 A 23:00 +1 / D 00:20 +2	511 / 217	PVG A 01:25 +2 A 01:25 +2				
PO1241 ⁴ / 214 PO1970 ⁴ / 214	777F / 747-8F 777F / 747-8F	D2 D3	ORD D 17:50 D 17:45	1241 / 1970	ICN A 23:05 +1 / D 22:25 +2 A 23:00 +1 / D 00:05 +3	214	NGO A 00:15 +3 A 01:55 +3				
PO1241 ⁴ / 214 / truck PO1970 ⁴ / 214 / truck	777F / 747-8F / truck 777F / 747-8F / truck	D2 D3	ORD D 17:50 D 17:45	1243	ICN A 23:05 +1 / D 22:25 +2 A 23:00 +1 / D 00:05 +3	214	NGO A 00:15 +3 / 21:00 +3 A 01:55 +3 / 21:00 +3	NRT A 06:00 +4 A 06:00 +4			
PO914 ⁴ / 1243 ⁴ / 989	777F / 747-8F	D5	ORD D 20:45	1875	ICN A 02:00 +2 / D 17:00 +2	989	SIN A 22:40 +2				
PO914 ⁴ / 1243 ⁴ / 751	777F / 747-8F	D5	ORD D 20:45	1875	ICN A 02:00 +2 / D 21:05 +4	751	SZX A 00:25 +5				
PO1970 ⁴ / 225 PO1243 ⁴ / 225	777F / 767F 777F / 767F	D3 D5	ORD D 17:45 D 20:45	1970 / 1243	ICN A 23:00 +1 / D 05:30 +2 A 02:00 +2 / D 05:10 +2	225	TPE A 07:10 +2 A 06:50 +2				
PO1876 ⁴ / 213	777F / 747-8F	D7	ORD D 20:45	1876	ICN A 02:00 +2 / D 22:25 +	214	NGO A 00:15 +4 / 21:00 +4	truck	NRT A 06:00 +4 / 09:50 +5	241	SYD D 21:50 +5

MEL destination cargo can be moved from SYD via truck or can connect PO246 SYD-MEL on D7

* Indicate Code Share Flight
¹ Marketing Carrier is PO. Operating Carrier is Aerologic (3S)
² Marketing Carrier is PO. Operating Carrier is Atlas Air (5Y)
³ Marketing Carrier is PO. Operating Carrier is Kalitta Air (K4)
⁴ Marketing Carrier is PO. Operating Carrier is Southern Air (9S)

▲ Indicate flight changes
 All times are local time
 Schedule is subject to change without prior notice